

Operating and Installation Instructions

Warming Drawer



To prevent accidents and machine damages, read these instructions **before** installation or use.

Contents

IMPORTANT SAFETY INSTRUCTIONS	3
Guide to the appliance	6
Warming drawer	6
Control panel	7
Standard accessories	8
Before using for the first time	9
Operation	10
Operating modes	10
Temperature settings	11
Duration	12
Keeping food warm	13
Warming dishes	15
Capacity	16
Other uses	17
Sabbath mode	18
Cleaning and care	19
Frequently asked questions	20
Optional accessories	21
IMPORTANT SAFETY INSTRUCTIONS	24
Installation dimensions	25
Installation	27
Installing the front panel	28
Electrical connection	30
Technical Service	31
Help protect our environment	32

IMPORTANT SAFETY INSTRUCTIONS

WARNING- When using your appliance follow basic precautions, including the following:

Read all instructions before installation or use to prevent injury and appliance damage.

This appliance conforms to all uniform safety codes and regulations.

Keep these operating instructions in a safe place and pass them on to any future user.

SAVE THESE INSTRUCTIONS

Proper use

- ▶ This gourmet warming drawer is intended for domestic use and similar installation conditions. Use only as described in this manual. Any other use is prohibited.
- ▶ This gourmet warming drawer is not designed for outdoors use.
- ▶ Persons who lack physical, sensory or mental abilities, or experience with the appliance should not use it without supervision or instruction by a responsible person.

Children

- ▶ Close supervision is necessary when any appliance is used by or near children.
- ▶ The appliance becomes hot during use and remains hot for some time after turning off. Keep children away from the warming drawer until it has cooled to a safe temperature.
- ▶ Ensure that any packing material, is disposed of safely and kept out of the reach of children. Danger of suffocation!

Technical safety

- ▶ Installation, repair and maintenance work should be performed by a Miele authorized service technician in accordance with local building and safety codes. Work by unqualified persons could be dangerous and may void the warranty.
- ▶ Before installing the appliance, check for externally visible damage. Do not operate a damaged appliance.
- ▶ Do not operate any appliance with a damaged cord. Contact Miele's Technical Service Department.
- ▶ To guarantee the electrical safety of this appliance, continuity must exist between the appliance and an effective grounding system. It is imperative that this basic safety requirement be met. If there is any doubt, have the electrical system of the house checked by a qualified electrician.

IMPORTANT SAFETY INSTRUCTIONS

▶ Before installation, make sure that the voltage and frequency listed on the rating label correspond with the household electrical supply. This data must correspond to prevent injury and appliance damage. Consult a qualified electrician if in doubt.

▶ Power bars and extension cords are not safe for use with this appliance. Risk of fire. Do not use them to connect the gourmet warming drawer to the electrical power supply.

▶ Do not use the appliance until it has been properly installed in the cabinetry.

▶ This gourmet warming drawer must not be operated in mobile installations (boats).

▶ Under no circumstance open the outer casing of the appliance. This is a safety hazard and may damage the appliance.

▶ Defective components should be replaced by Miele original spare parts only. Only with these parts can the manufacturer guarantee the safety of the appliance.

▶ Do not operate any appliance with a damaged cord or plug, or if the appliance has been damaged in any manner. Contact Miele's Technical Service Department.

▶ Before servicing, turn off the gas valve and disconnect the power supply by either removing the fuse, unplugging the unit or manually "tripping" the circuit breaker.

Proper use

▶ Protect your hands with oven mitts or potholders when using the appliance. Use only dry, heat resistant potholders. Moist or damp potholders used on hot surfaces can result in steam burns.

▶ Do not store plastic containers or flammable objects in the drawer. They can melt or catch fire when the appliance is turned on. Fire hazard!

▶ The use of accessories not recommended by Miele may cause injury.

▶ Make certain that the power cords of small appliances do not come in contact with the appliance. The insulation of the cable could become damaged. Danger of electric shock!

▶ Objects in the vicinity of the activated drawer may burn due to the high temperatures. Never use the appliance to heat rooms.

▶ Do not replace the non-slip mat with kitchen towels or similar objects.

▶ Do not overload the appliance or sit or stand on the opened drawer as this would damage the drawer. The drawer can be loaded with maximum 55 lbs (25 kg).

▶ If the appliance is installed in a closed kitchen cabinet, only use it when the cabinet door is open.

IMPORTANT SAFETY INSTRUCTIONS

- ▶ Do not heat unopened food containers. Pressure can build up causing an explosion that will damage the cooking compartment. There is also a danger of personal injury and scalding.
- ▶ Before serving, be sure food is at a safe temperature. This is particularly important when preparing food for babies and children.
- ▶ Be aware of loose fitting or hanging clothing while using the warming drawer. They may present a fire hazard.
- ▶ The floor of the drawer becomes hot during use. Caution, do not touch. Use the handle for opening and closing the appliance.
- ▶ Do not use plastic containers or plastic wrap in the warming drawer. These items may melt and cause damage to the warming drawer or injury.
- ▶ Never warm undiluted alcohol in the warming drawer, this can easily ignite.
- ▶ Exercise caution when warming food with a high sugar content. If heated for too long the sugar may caramelize or ignite.
- ▶ Be sure that the vents are not covered. Food and tableware may not warm evenly otherwise.
- ▶ Do not leave the warming drawer unattended while in use.
- ▶ Do not use water on grease fires! A violent steam explosion may result. Smother the fire with a dry chemical or foam fire extinguisher.
- ▶ Never add water to food in a hot drawer. The steam created could cause serious burns or scalds.
- ▶ Liquids entering the appliance interior through the air vents may cause a short-circuit. Open and close the loaded drawer carefully to prevent liquids from spilling.
- ▶ The "Keep food warm" operating mode must be only used for keeping hot food warm, but not for heating cold food. Ensure that the food is sufficiently heated before you place it in the appliance.
- ▶ It is possible that some bacterial growth may occur in foods kept for lengthy period of time at low temperature levels.
- ▶ Do not use a steam cleaner to clean the drawer. Steam could penetrate electrical components and cause a short circuit.

SAVE THESE INSTRUCTIONS AND REVIEW THEM PERIODICALLY

Guide to the appliance

Warming drawer

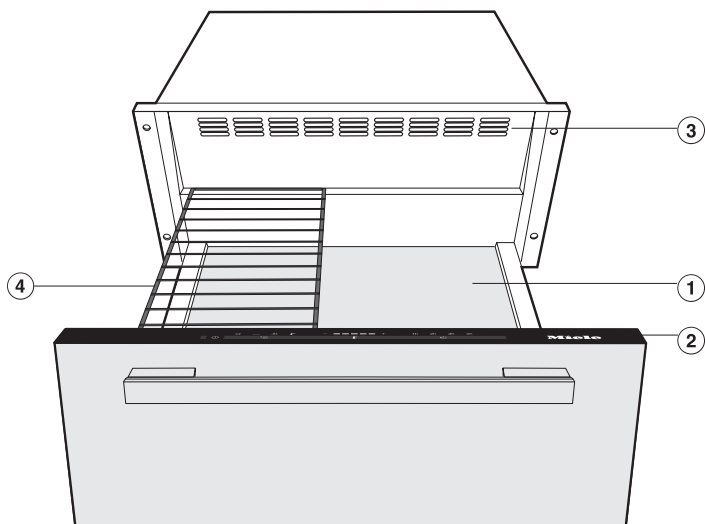

- ① Non-slip mat
- ② Control panel
- ③ Vents
- ④ Rack

Control panel

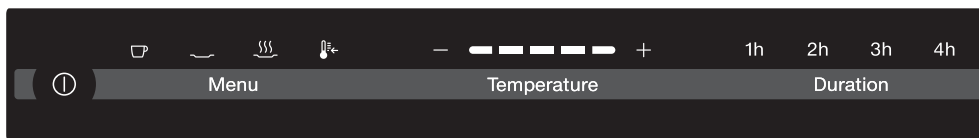





Sensors

-  Turns the warming drawer on and off
- Menu Selects the operating mode
- Temperature Sets the temperature
- Duration Sets the duration

Indicators

Operating modes:

-  For warming cups and glasses
-  For warming plates and dishes
-  For keeping food warm
-  For low temperatures

Temperature:



Duration:

- 1h 1 hour
- 2h 2 hours
- 3h 3 hours
- 4h 4 hours

Guide to the appliance

Standard accessories

All standard and additional accessories can be reordered if necessary (see "Optional accessories") from Miele.

Rack

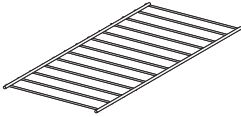

For increasing the loading area

Non-slip mat

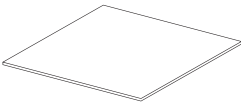

Provides a secure base for your dishes

Before using for the first time

Clean and heat the appliance

- Remove any protective wrapping.
- Remove the non-slip mat and the rack, if provided, from the appliance and clean both with a sponge cloth, warm water and liquid dish soap. Then dry with a cloth.
- Wipe your appliance inside and outside with a damp cloth and then dry.
- Reinsert the non-slip mat and the rack, if provided.

Heat the empty drawer for at least 2 hours.

- Touch the ON/OFF sensor ① to turn the appliance on.
- Tap "Menu" until the  symbol is illuminated.
- Tap "Temperature" until the LED on the far right is illuminated.
- Tap "Duration" until 2h is illuminated.
- Close the drawer.

The heater and the fan of the appliance will only turn on when the drawer is closed.

The appliance will turn off automatically after two hours.





Metal components have a protective coating which may give off a slight odor the first time your new appliance is heated. The smell will dissipate after a short time and does not indicate a faulty connection.

Ensure proper ventilation of the area during this time.

Operation

Operating modes

Touch the "Menu" sensor to select the operating mode; the corresponding symbol will be illuminated:

-  Warming cups and glasses
-  Warming dishes and plates
-  Keeping food warm
-  Low temperature

The last selected operating mode is automatically set when the appliance is turned on the next time and will be displayed on the control panel.

The appliance is fitted with a fan distributing the warmed air within the drawer. The fan runs continuously in the "Cups/glasses" and "Warming dishes/plates" modes. It works intermittently in the "Keeping food warm" and "Low temperature" modes.









The appliance lets you keep food warm while simultaneously warming dishes. For this purpose, use the "Keeping food warm" operating mode.

Caution! The dishes need more time to warm up but may become very hot!

Temperature settings

Every operating mode has its own temperature range. The factory settings for recommended temperatures are shown in **bold**. By touching the  sensor, you can change the temperature in 5 degree increments.

The last selected temperature is automatically set when the appliance is turned on the next time and will be displayed on the control panel (Exception: Low temperature).

Temperature Display	Temperature °F / °C *			
				
	104 / 40	140 / 60	150 / 65	150 / 65
	113 / 45	150 / 65	158 / 70	158 / 70
	122 / 50	158 / 70	167 / 75	167 / 75
	131 / 55	167 / 75	176 / 80	176 / 80
	140 / 60	176 / 80	185 / 85	185 / 85

* Approximate temperatures, measured in the center of an empty drawer

Operation

Duration

The appliance is set to continuous operation (Exception: Low temperature).

You can select a limited duration by touching the "Duration" sensor: 1 touch: 1 hour (1h), 2 touches 2 hours, (2h), and so on, up to a maximum of 4 hours. A fifth touch returns the appliance to continuous operation.

Do not leave the appliance unattended for longer periods of time when in continuous mode. Long warming times cause food to dry out and possibly burn. Your appliance is fitted with a safety device that will turn the warming drawer off after 12 hours (max.) of continuous use.

Operating principle

- Open the drawer.
- Touch the ON/OFF sensor ① to turn the appliance on.
- Tap "Menu" until the desired operating mode is illuminated.
- If you want to change the temperature, tap "Temperature" until the LED with the desired temperature is illuminated.
- Tap "Duration" until the desired number of hours is illuminated.
- Close the drawer.

Keep the ON/OFF sensor ① clean and dry. The sensor key may not respond otherwise, or cause uncontrolled switching actions.

Select only the  operating mode to ensure that the required minimum temperature (150 °F / 65 °C) for keeping food warm is maintained.

This mode is for keeping food that has just been cooked warm, that is, food that is still hot. It is not intended for reheating food that is cold.

- Select .
- Select the desired duration.
- Preheat the appliance for 15 minutes to ensure that the interior has reached the required temperature. Put the dishes into the drawer during preheating.
- Remove the warmed dishes from the drawer. Use pot holders when removing the dishes.
- Place hot food on warmed dishes.
- Replace the dishes in the drawer, and carefully close the drawer to prevent liquid food from spilling.

Tips

- Fill the hot food into pre-warmed dishes. Put the dishes into the drawer during preheating.
- Do not cover roasted or fried food that should be crispy. Keep these foods warm at a higher temperature.
- Moist and liquid foods, and those that may generate a skin, should be covered with aluminum foil or a plate.
- Do not overfill dishes to prevent spilling.
- Freshly prepared food is hotter than food kept warm. Serve food kept warm on warmed plates.
- Loss of nutrients begins with the preparation of the food and continues while it is being kept warm. The longer food is kept warm, the greater the loss of nutrients.
- It is not recommended to keep food warm over a longer period of time, as it will continue to cook.
- Do not use force when opening or closing the drawer. Liquid may spill from the containers and enter the ventilation slots.
- The food may cool down if the drawer is opened frequently.

Keeping food warm

Settings

Food	Dishes	Cover dishes	Temperature at setting ^{SSS}	Position	
				Bottom	Rack*
Steak, rare	Plate	no	■ □ □ □ □	x	x
Casserole, soufflé, gratin	Gratin dish	yes	□ □ □ ■ □	x	
Roast	Plate	yes	□ □ ■ □ □	x	
Stew	Pot	yes	□ □ □ ■ □	x	
Meat in gravy	Pot	yes	□ □ □ ■ □	x	
Vegetable in sauce	Pot	yes	□ □ □ ■ □	x	
Mashed potatoes	Pot	yes	□ □ ■ □ □	x	
Plated meal	Plate	yes	□ □ □ ■ □	x	
Baked potato/ Boiled potato	Plate/pot	yes	□ □ ■ □ □	x	
Breaded poultry / meat	Pan	no	□ □ □ □ ■	x	
Pancakes	Plate	no	□ □ □ □ ■	x	x
Pizza	Plate	no	□ □ □ □ ■	x	
Sauce	Pot	yes	□ □ □ ■ □	x	
Strudel	Plate	no	□ □ □ ■ □	x	
Warming bread loaf	-	no	■ □ □ □ □	x	x
Warming rolls	-	no	■ □ □ □ □	x	x

* Depending on the appliance mode

- Try to distribute the dishes over the entire surface. High stacks of plate will warm up slower than individual dishes. If you cannot avoid plate stacks, place them in the front of the appliance. Use the rack (if provided with your model).
- Do not place large platters vertically in front of the venting slots. They will cover the outlets for the warm air. The dishes won't be warmed up evenly.
- For cups and glasses, use only the ☐ mode to ensure that the maximum temperature (140 °F / 60 °C) is not exceeded.
- Warmed dishes will quickly lose their heat. Remove them only immediately prior to use.
-

Warming times

Various factors can affect the heating time:

- Material and thickness of your dishes
- Load size
- Load distribution
- Temperature setting

Use the following values as guidelines:

When set to ☐, even warming requires the times shown in the list below:

- Place settings for 6 persons
approx. 30 - 35 minutes
- Place settings for 12 persons
approx. 40 - 45 minutes
- With time you will get to know the optimum settings for your household.

Warming dishes

Capacity

The quantity that can be loaded depends on the size and weight of your dishes.
Do not overload the drawer. The maximum load is 55 lbs (25 kg).

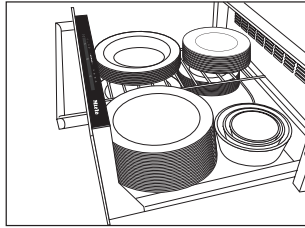



The following examples are provided as guidelines:

- 12 place settings:
 - 12 dinner plates Ø 10 1/4" (26 cm)
 - 12 soup bowls Ø 9 1/16" (23 cm)
 - 12 dessert plates Ø 7 1/2 (19 cm)
 - 1 oval platter 12 5/8" (32 cm)
 - 1 serving dish Ø 7 1/2 (19 cm)
 - 1 serving dish Ø 6 5/16 (16 cm)
 - 1 serving dish Ø 5 1/8" (13 cm)

- or alternatively
- 40 dinner plates Ø 10 1/4" (26 cm)
 - 60 soup bowls Ø 9 1/16" (23 cm)
 - 45 soup cups Ø 4" (10 cm)
 - 20 dinner plates Ø 10 1/4" (26 cm)
 - 20 soup bowls Ø 9 1/16" (23 cm)
 - 20 pizza plates Ø 14 3/16" (36 cm)
 - 142 espresso cups Ø 2 5/16" (5.9 cm)
 - 90 cappuccino cups Ø 2 11/16" (8.8 cm)
 - 30 tea glasses Ø 2 5/8" / 3 1/8"
(6.7 cm/8 cm) height

You can increase the load area by using the rack. The rack can be used as needed. With two racks you can increase the load area even more by placing one rack on the left and the other on the right. You can obtain another rack from Miele.

Other uses

Food	Dishes	Cover dishes	Temp. at setting 	Temp. at setting 	Position		Duration in hours: min.
					Bottom	Rack*	
Defrosting berries	Bowl/plate	no	<input checked="" type="checkbox"/> <input type="checkbox"/> <input type="checkbox"/> <input type="checkbox"/> <input type="checkbox"/>		x		0:50
Dissolving gelatin	Bowl	no	<input type="checkbox"/> <input type="checkbox"/> <input type="checkbox"/> <input type="checkbox"/> <input checked="" type="checkbox"/>		x	x	0:15
Proofing yeast dough	Bowl	yes with plate		<input checked="" type="checkbox"/> <input type="checkbox"/> <input type="checkbox"/> <input type="checkbox"/> <input type="checkbox"/>	x		0:30
Preparing yogurt	Yogurt glasses with lid	-		<input type="checkbox"/> <input checked="" type="checkbox"/> <input type="checkbox"/> <input type="checkbox"/> <input type="checkbox"/>	x		5:00
Soaking rice pudding	Pot	yes with lid	<input type="checkbox"/> <input type="checkbox"/> <input type="checkbox"/> <input type="checkbox"/> <input checked="" type="checkbox"/>		x	x	0:40
Melting chocolate	Bowl	no	<input type="checkbox"/> <input type="checkbox"/> <input type="checkbox"/> <input type="checkbox"/> <input checked="" type="checkbox"/>		x	x	0:20
Defrosting vegetables	Bowl	no	<input type="checkbox"/> <input type="checkbox"/> <input checked="" type="checkbox"/> <input type="checkbox"/> <input type="checkbox"/>		x		1:00

* Depending on appliance model

Sabbath mode

Sabbath mode can be selected to facilitate religious customs. Sabbath mode will turn off after about 72 hours and normal operation will resume.

In Sabbath mode the timer is deactivated and the sensors have to be touched longer than usual.

To activate

- Press and hold the **Duration** sensor.
- At the same time press and hold the ① sensor.
- Press and hold both sensors until all 4 timer indicators light up.
- Select the desired operating mode and temperature.

To deactivate

You can deactivate the Sabbath mode before the 72 hours are up.

- Press and hold the ① sensor until all the indicators go out.
- The drawer returns to normal operation.

Allow the appliance to cool before cleaning.

Do not use a steam cleaner to clean this appliance. Pressurized steam could penetrate electrical components and cause a short circuit.

Do not use commercial cleaning agents. Only use agents recommended for domestic use.

Appliance front / interior

Remove spills as soon as possible. Otherwise the soiling may become hard to remove.

If spills are allowed to sit for an extended period of time or if unsuitable cleaning agents are used the surfaces may discolor or change.

- Clean the appliance with a solution of warm water and liquid soap applied with a soft sponge. Dry with a soft cloth.

All surfaces of the appliance are susceptible to scratching. Breakages can occur on glass surfaces.

Glass cleaners may be used to clean the exterior. However **do not** allow them to sit or "puddle", this can cause damage to the surface.

Remove the cleaner promptly.

To better maintain your appliance avoid the following:

- cleaners containing soda, ammonia, thinners, or chlorides
- cleaners containing descaling agents or lime removers,
- abrasive cleaners,
- stainless steel cleaners,
- dishwasher soap (powder),
- caustic (oven) cleaners,
- scouring pads, steel wool, hard brushes,
- metal scrapers.

Non-slip mat

The mat can be removed to clean the bottom of the drawer.

- Clean the mat by hand with warm water and liquid dish soap.
- Dry thoroughly. Do not return the mat until it is completely dry.

Never clean in the washing machine.

Frequently asked questions

 Repairs should only be carried out by an authorized technician in accordance with local and national safety regulations. Unauthorized repairs could cause injury or appliance damage.

What if the drawer does not heat?

Possible fault	Solution
There is no power to the warming drawer.	Insert the plug into the outlet.
The circuit breaker has tripped.	Reset the circuit breaker. If in doubt contact an electrician.

What if the food is not warm enough?

Adjust the temperature setting. Check that the vents have not been blocked by large plates or dishes.

What if the food or dishes are too hot?

Check the temperature setting and make sure the food is not too close to the heating element.

What if the dishes are not warm enough?

Possible fault	Solution
The wrong temperature was selected.	Check the temperature setting.
The vents were blocked by dishes.	Reload the dishes.
The dishes need more time to warm.	See "Warming times".

A noise is heard during use.

This is not a fault. This is the circulation fan which distributes the heated air. The fan works in intervals during the "☰ Keep food warm" mode.

Miele offers a variety of additional accessories for its appliances including Miele cleaning and conditioning products.

These products can be easily ordered from Miele.

Rack

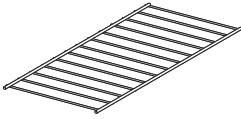

For increasing the load capacity.

Non-slip mat

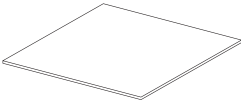

To keep the dishes securely in place

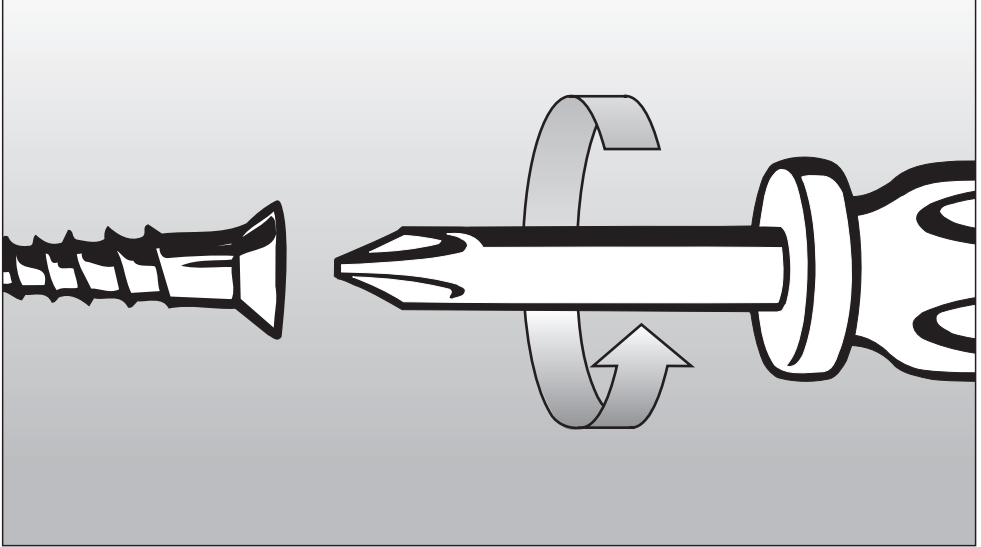

Installation Instructions

IMPORTANT: SAVE FOR THE LOCAL ELECTRICAL INSPECTOR'S USE

Information is subject to change.
Please refer to our website to obtain the most current product specification,
technical & warranty information.

To prevent accidents
and machine damage
read these instructions
before
installation or use.

IMPORTANT SAFETY INSTRUCTIONS

▶ Before installation make sure that the voltage and frequency listed on the data plate correspond with the household electrical supply. This data must correspond in order to avoid risk of damage to the appliance. If in doubt, consult a qualified technician.

▶ The electrical outlet should be easily accessible after installing the unit.

▶ The gourmet warming drawer must be installed only in combination with other appliances specified by Miele. When installed with other appliances, the warranty is void since the manufacturer cannot guarantee the safe use of the warming drawer.

▶ A solidly installed base must be present for the installation of the gourmet warming drawer and the combination device to ensure the required load carrying capacity for both appliances.

▶ The combination appliance is placed directly onto the installed gourmet warming drawer; an intermediate base is not required.

▶ The appliance must be installed in such a manner that the contents of the dishes can be seen. Scalding due to spilling of hot food can be avoided. Sufficient space must be given to pull the drawer out.

▶ The gourmet warming drawer is available in two variants differing in height. The required **niche dimensions** result from the installation dimensions of the gourmet warming drawer and the installation dimensions of the combination device.

Note to the installer:

Please leave these instructions with the consumer of the appliance for the local building inspectors use.

SAVE THESE INSTRUCTIONS

Installation dimensions

Solo installation

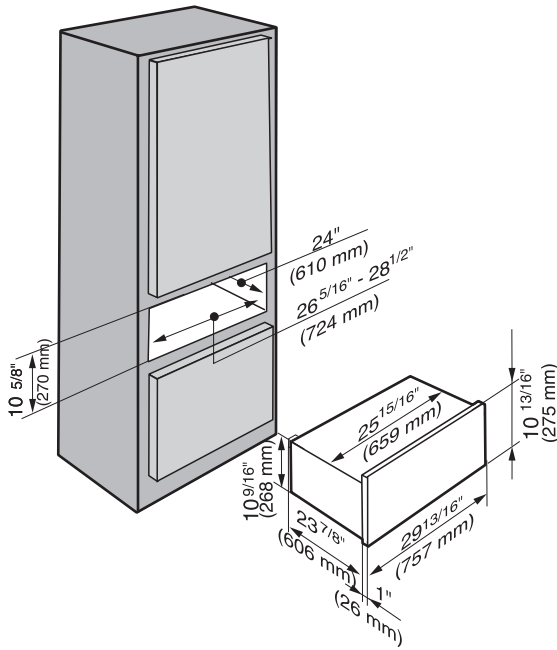

Side view

① Fixed shelf

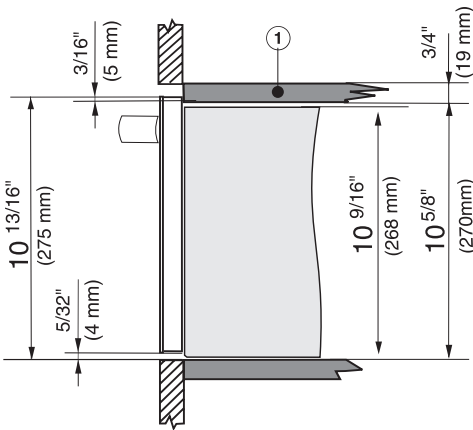

* Appliances with glass front

** Appliances with stainless steel front

Installation dimensions

Installation with an oven

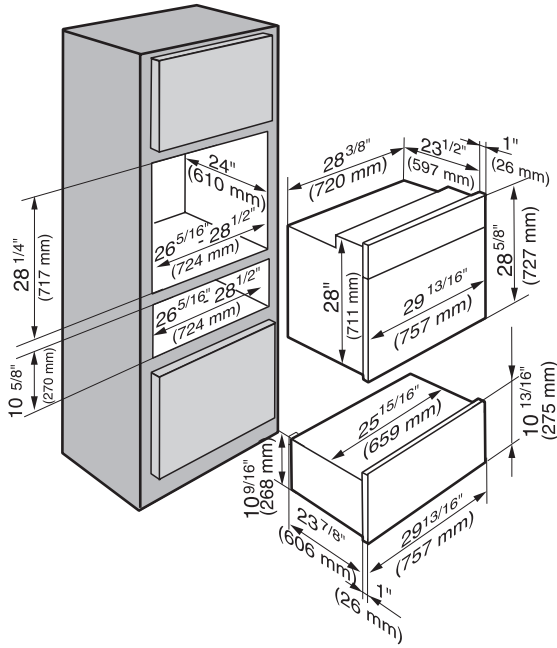

Side view with oven

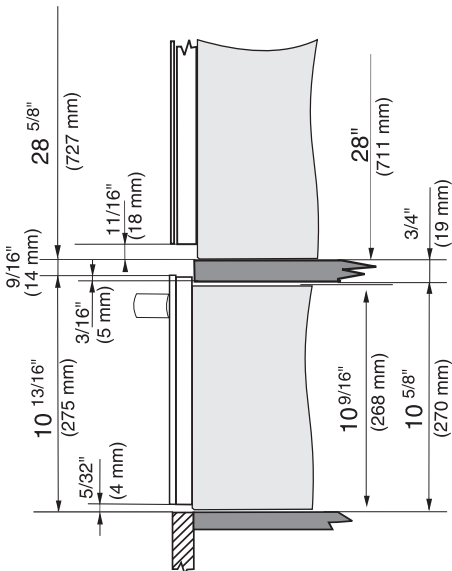

* Appliances with glass front

** Appliances with stainless steel front

Check that the base of the warming drawer is clean and level. Only then will it function properly.

When inserting the appliance, wear work gloves to avoid injuries.

- Push the drawer into the cabinet as far as the vapor strip, and align it.

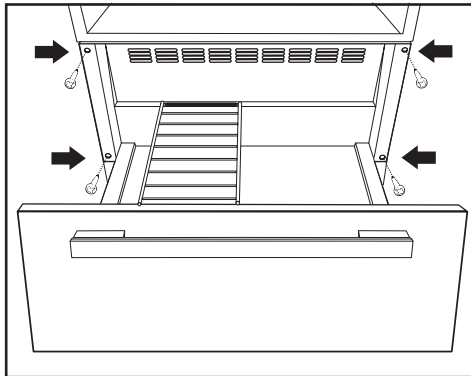

- Open the drawer, and use the 4 screws provided to secure the drawer to the side walls of the cabinet.
- Install the combination appliance according to the manual included with that appliance.

Installing the front panel

ESW 6380 FB

The front panel must be at least 3/4" (19 mm) thick and made of heat resistant material 140° F (60° C). The front panel, including handle, must not exceed 11 lb (5 kg) in weight.

- Attach the handle to the front panel using countersunk screws.
- Remove the screws from the left and right sides of the drawer front and carefully lift the control panel out. Be

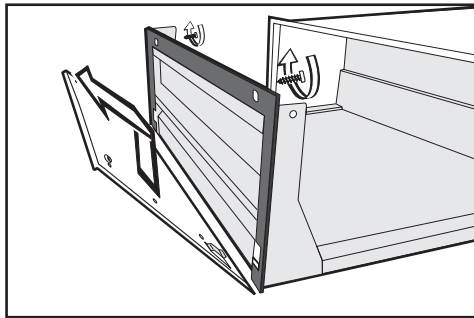

careful not to pull on or damage the power cord.

- Remove the two screws on the inside of the front and

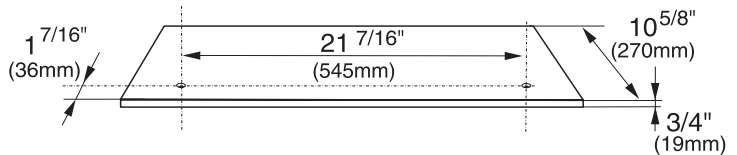

remove the panel from the front of the drawer.

- Pre-drill the custom front panel (see illustration).
Ø 3/8" (10 mm), t = 3/8" (10 mm)

Installing the front panel

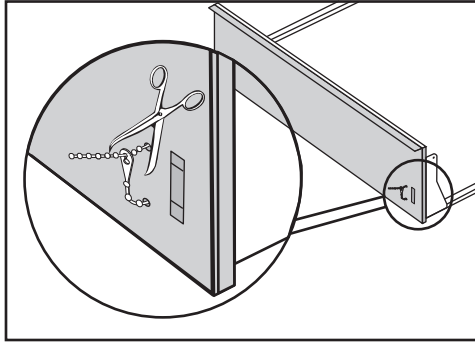

- Remove the cable tie from the panel.

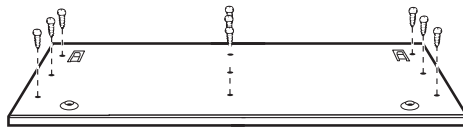

- Screw the removed panel to the front panel (see illustration).

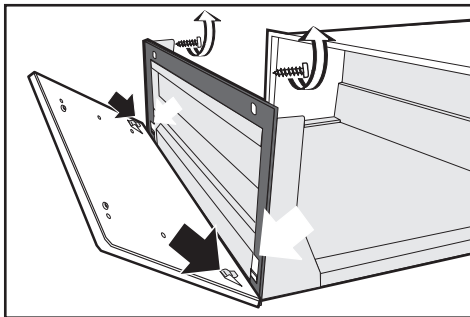

- Hook the panel into the bottom. Make sure the seal is seated correctly.
- Replace and slightly tighten the screws on the inside of the drawer front.
- Align the front.
- Tighten the screws on the inside of the drawer front.
- Replace the control panel. Use caution with the power cord.
- Replace and tighten the screws on the left and right side of the drawer front.

Electrical connection

 **CAUTION:** Before servicing, disconnect the power supply by either removing the fuse, shutting off the power main or manually "tripping" the circuit breaker.

Installation work and repairs should only be performed by a qualified technician in accordance with all applicable codes and standards. Repairs and service by unqualified persons could be dangerous.

Before connecting the appliance to the power supply, make sure that the voltage and frequency listed on the data plate correspond with the household electrical supply. This data must correspond to prevent machine damage. Consult an electrician if in doubt.

When another appliance is installed in combination with the warming drawer to the same circuit, operating both appliances at the same time may cause an overload. If in doubt consult a qualified electrician.

Power supply

This appliance is equipped with a 5 ft (1.5 m) long power cord with a three-prong grounding plug ready for connection to a 120 V, 15 A, 60 Hz power supply.

Further installation details are on the wiring diagram.

In the event of a fault which you cannot easily fix yourself, please contact the Miele Technical Service Department at the address on the back of this booklet.

When contacting Technical Service please quote the serial number and model of the appliance. This information is visible on the silver data plate supplied with the appliance.

MieleCare

(USA only)

MieleCare, our Extended Service Contract program; gives you the assurance of knowing that your appliance investment is covered by 5 years of worry free ownership.

MieleCare is the only Extended Service Contract in the industry that guarantees repairs by a Miele Authorized Service Provider using genuine Miele parts. Only genuine Miele parts installed by factory trained professionals can guarantee the safety, reliability and longevity of your Miele appliance.

Please note that unless expressly approved in writing by the Miele Service department, Extended Service Contracts offered by other providers for Miele products will not be recognized by Miele. Our goal is to prevent unauthorized (and untrained) service personnel from working on your Miele products, possibly doing further damage to them, you and/or your home.

To learn more about **MieleCare** Extended Service Contracts, please contact your appliance dealer or visit us online at:

<http://mieleusa.com/mielecare>

Help protect our environment

Disposal of packing materials

The cardboard box and packing materials are biodegradable and recyclable. Please recycle.

Ensure that any plastic wrappings, bags, etc. are disposed of safely and kept out of the reach of children.

Danger of suffocation!

Disposal of an old appliance

Old appliances contain materials that can be recycled. Please contact your local recycling authority about the possibility of recycling these materials.

Before discarding an old appliance disconnect it from the electrical supply and cut off the power cord to prevent it from becoming a hazard.

Please have the model and serial number of your appliance available before contacting Technical Service.



U.S.A.
Miele, Inc.

National Headquarters

9 Independence Way
Princeton, NJ 08540
Phone: 800-843-7231
609-419-9898
Fax: 609-419-4298
www.mieleusa.com

Technical Service & Support
Nationwide

Phone: 800-999-1360
Fax: 888-586-8056

TechnicalService@mieleusa.com

Canada
Miele Limited

Headquarters and Showroom

161 Four Valley Drive
Vaughan, ON L4K 4V8
Phone: 800-643-5381
Fax: 905-532-2290
www.miele.ca
professional@miele.ca
(commercial enquiries)

MieleCare National Service

Phone: 800-565-6435
905-532-2272
Fax: 905-532-2292
customercare@miele.ca
(general and technical enquiries)



www.miele-shop.com

INFORMATION IS SUBJECT TO CHANGE. PLEASE REFER TO OUR WEBSITE TO OBTAIN THE MOST CURRENT PRODUCT SPECIFICATIONS, TECHNICAL & WARRANTY INFORMATION.

ESW 6380 / ESW 6380 FB / ESW 6580 / ESW 6680 / ESW 6780
ESW 6880